

TecoLED | 

*Products Catalogue*

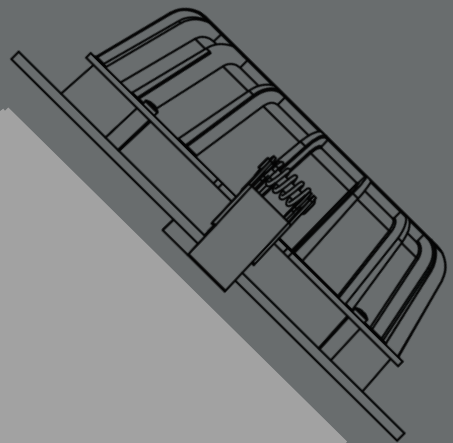

*Minimal design, Maximum power*



## TecoLED: The Meeting Point of Technology, Quality, and Sustainability

*TecoLED, developed with **Fiberli's** expertise and experience, stands out as a new brand aimed at bringing high-quality lighting products to a broader audience. Built on Fiberli's high standards, **TecoLED** offers both affordable and user-friendly solutions tailored to individual and commercial needs.*

*Designed with a minimalist approach and resource-friendly production processes, **TecoLED** products prioritize reduced raw material usage and eco-friendly features. This innovative approach combines durability and aesthetics with accessible pricing, offering long-term value to users. **TecoLED** bridges Fiberli's design and engineering principles with accessible products, ensuring a high-quality, efficient experience without compromise.*

*With the slogan "**Minimal design, Maximum power,**" **TecoLED** unites functionality and aesthetics in every living space. Our products, crafted with Fiberli's expertise, make quality lighting accessible to all.*

*Enjoy reliable and economical lighting with **TecoLED!***

|   |   |   |   |  |   |   |
|---|---|---|---|--|---|---|
|  |  |  |  |  |  |  |
| WH4 - TECO  | WH6 - TECO  | WH9 - TECO  | WH16 - TECO   | RODA - EVO   | LLTMS - TECO  | LLKE - TECO   |
|  |  |  |  |  |  |   |
| CRAKE - TECO  | CDEW - TECO   | CRDS - TECO   | PANEL CLIP IN - TECO  | PANEL LAY IN - TECO  | AC56 - TECO   |   |

# WH4 - TECO

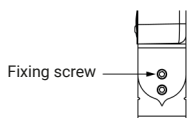
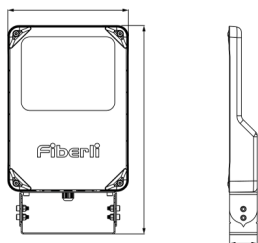

## P W Product & Power Options

| Product Name | Light Color | Input Voltage (V) | Power (W) | Luminous Flux (lm) | Weight (kg) |
|--------------|-------------|-------------------|-----------|--------------------|-------------|
| WH4-TECO     | WW-NW-CW    | 220-240V AC       | 30        | 4.110              | 3,6         |
| WH4-TECO     | WW-NW-CW    | 220-240V AC       | 50        | 6.710              | 3,6         |

## C Light Color Options

- WW: Warm White 3000K
- NW: Natural White 4000K
- CW: Cold White 6500K

## G Housing Color Options



- Electrostatic powder coated aluminum injection housing
- High cooling capacity body design
- 5mm, tempered luminaire glass
- Stainless fittings and clips
- Electrostatic painted DKP / Galvanized mounting feet

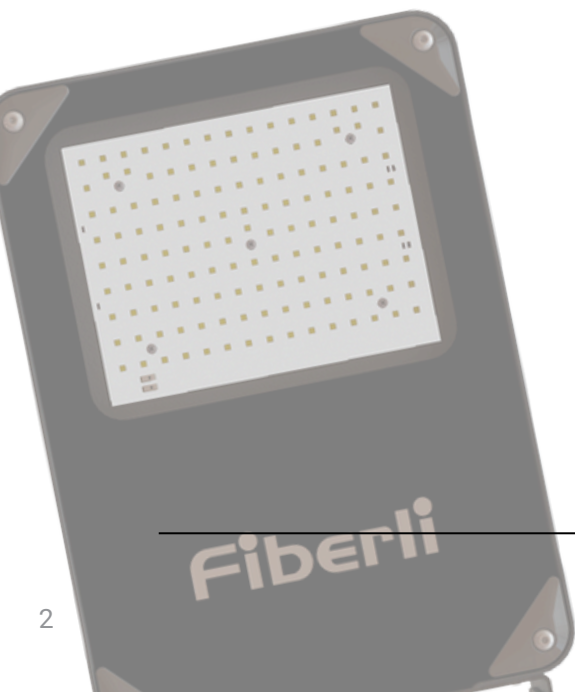

# WH6 - TECO

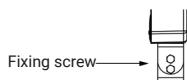
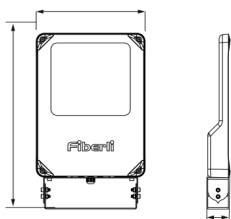

## P W Product & Power Options

| Product Name | Light Color | Input Voltage (V) | Power (W) | Luminous Flux (lm) | Weight (kg) |
|--------------|-------------|-------------------|-----------|--------------------|-------------|
| WH6-TECO     | WW-NW-CW    | 220-240V AC       | 75        | 10.732             | 4,1         |
| WH6-TECO     | WW-NW-CW    | 220-240V AC       | 100       | 13.350             | 4,1         |

## C Light Color Options

- WW: Warm White 3000K
- NW: Natural White 4000K
- CW: Cold White 6500K

## G Housing Color Options



- Electrostatic powder coated aluminum injection housing
- High cooling capacity body design
- 5mm, tempered luminaire glass
- Stainless fittings and clips
- Electrostatic painted DKP / Galvanized mounting feet

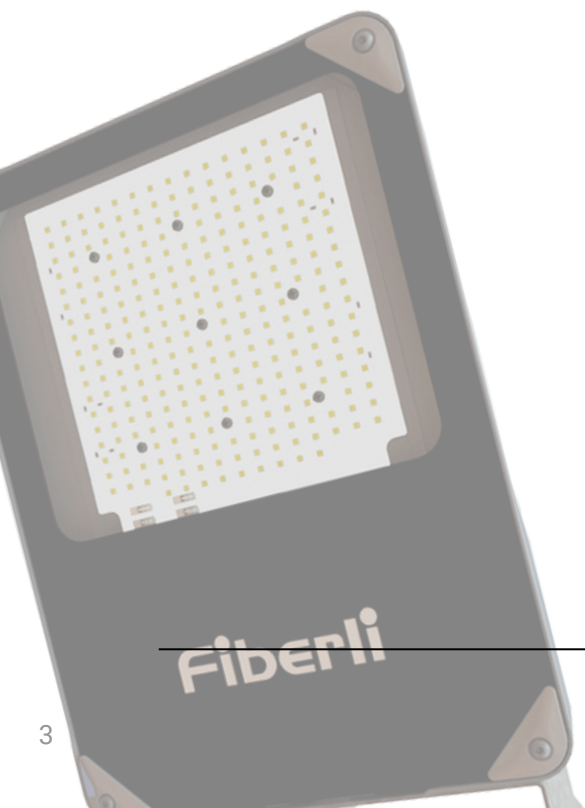

# WH9 - TECO

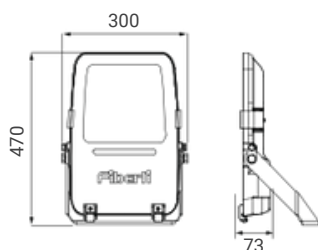

## P W Product & Power Options

| Product Name | Light Color | Input Voltage (V) | Power (W) | Luminous Flux (lm) | Weight (kg) |
|--------------|-------------|-------------------|-----------|--------------------|-------------|
| WH9-TECO     | WW-NW-CW    | 220-240V AC       | 150       | 19.949             | 5,20        |

## C Light Color Options

- WW: Warm White 3000K
- NW: Natural White 4000K
- CW: Cold White 6500K

## G Housing Color Options

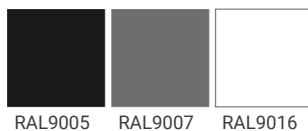

- Electrostatic powder coated aluminum injection housing
- High cooling capacity body design
- 4mm tempered luminaire glass
- Aluminum injection side covers

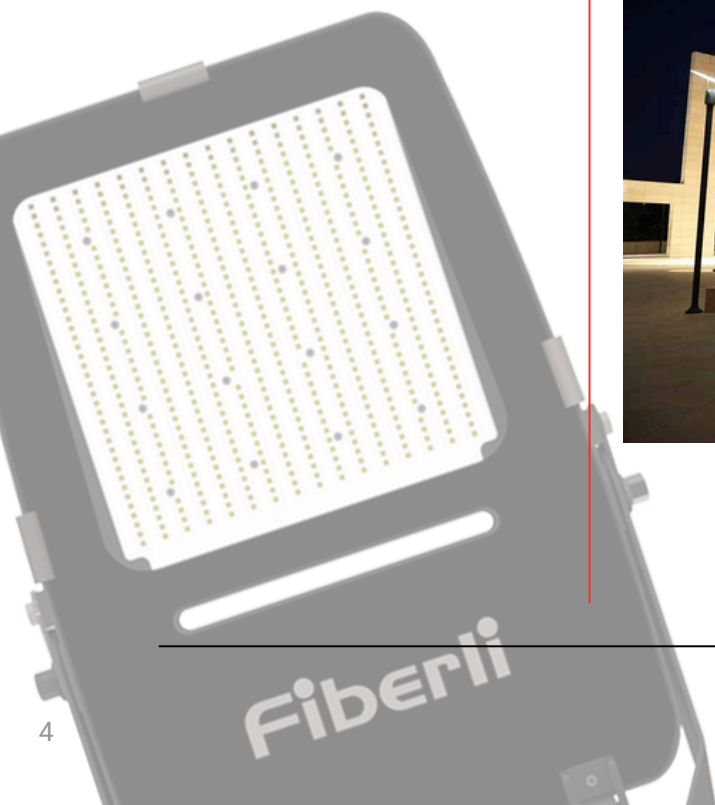

# WH16 - TECO

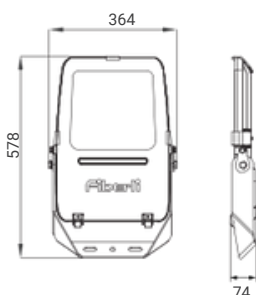

## P W Product & Power Options

| Product Name | Light Color | Input Voltage (V) | Power (W) | Luminous Flux (lm) | Weight (kg) |
|--------------|-------------|-------------------|-----------|--------------------|-------------|
| WH16-TECO    | WW-NW-CW    | 220-240V AC       | 200       | 26.129             | 6,90        |
| WH16-TECO    | WW-NW-CW    | 220-240V AC       | 250       | 33.140             | 6,90        |

## C Light Color Options

- WW: Warm White 3000K
- NW: Natural White 4000K
- CW: Cold White 6500K

## G Housing Color Options

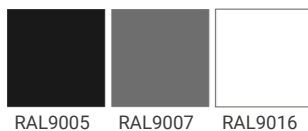

- Electrostatic powder coated aluminum injection housing
- High cooling capacity body design
- 4mm tempered luminaire glass
- Aluminum injection side covers

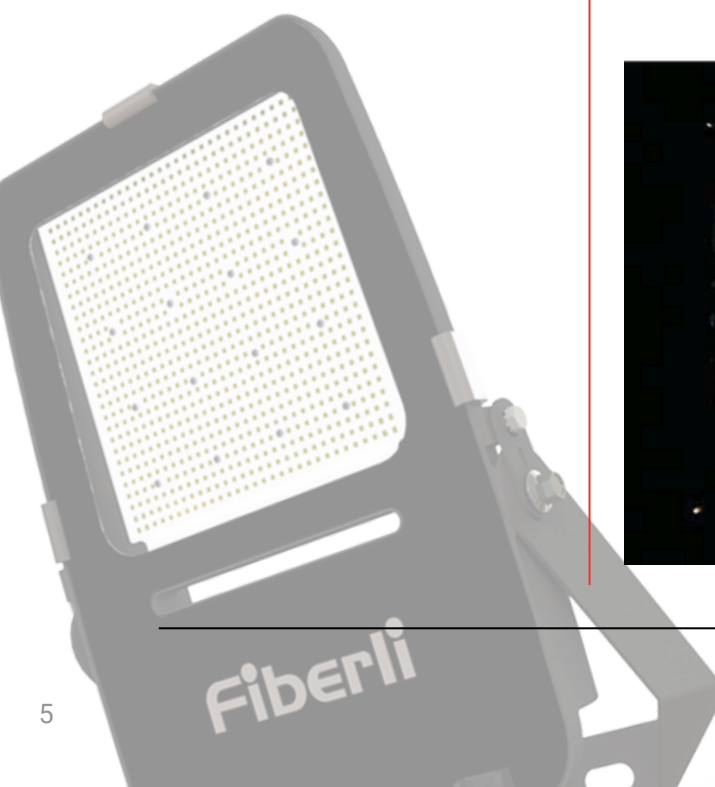
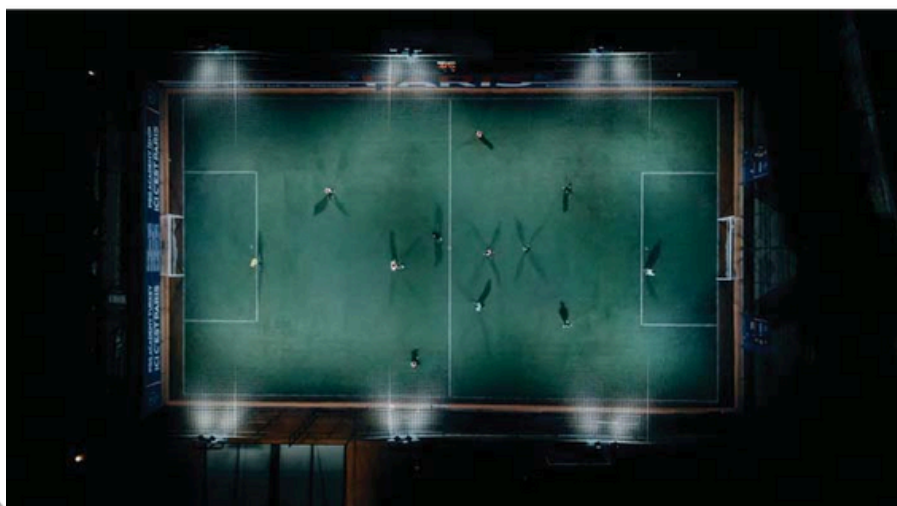

# RODA EVO

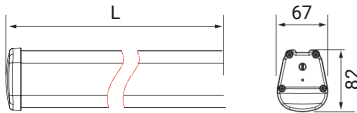
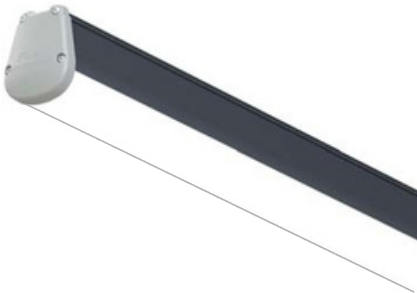

## P W Product & Power Options

| Product Name | Light Color | Input Voltage (V) | Power (W) | Luminous Flux (lm) | Length (mm) | Weight (kg) |
|--------------|-------------|-------------------|-----------|--------------------|-------------|-------------|
| RODA60 EVO   | WW-NW-CW    | 220 - 240 AC      | 18        | 1.980              | 624         | 0.7         |
| RODA120 EVO  | WW-NW-CW    | 220 - 240 AC      | 36        | 3.967              | 1224        | 1,3         |

## C Light Color Options

- WW: Warm White 3000K
- NW: Natural White 4000K
- CW: Cold White 6500K

## S Driver Options

01 Standart Driver

06 DALI Driver

ACK Emergency Lighting Kit 3h

- High efficiency waterproof LED luminaire
- Extended PC body
- UV protected PVC end caps
- High efficiency diffuser with homogeneous light output
- Stainless fittings
- Optional DALI and Emergency Kit
- Protection level IP 65



# LLTMS - TECO

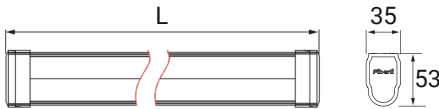
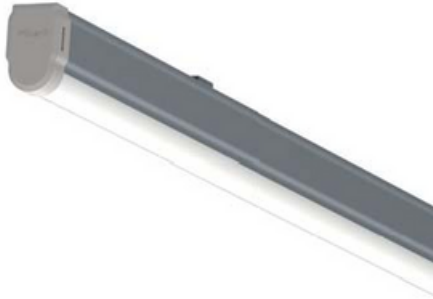
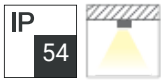

## P W Product & Power Options

| Product Name    | Light Color | Input Voltage (V) | Power (W) | Luminous Flux (lm) | Length (L) (mm) | Weight (kg) |
|-----------------|-------------|-------------------|-----------|--------------------|-----------------|-------------|
| LLTMS60 - TECO  | WW-NW-CW    | 220-240V AC       | 18        | 2070               | 631             | 0,7         |
| LLTMS120 - TECO | WW-NW-CW    | 220-240V AC       | 36        | 4140               | 1231            | 1,2         |

\*Power and Lumen values provided are based off of a "cold white (CW) LED".

## C Light Color Options

|                           |                  |
|---------------------------|------------------|
| ● WW: Warm White 3000K    | ● R: Red 625nm   |
| ● NW: Natural White 4000K | ● G: Green 525nm |
| ● CW: Cold White 6500K    | ● B: Blue 465nm  |
|                           | ● A: Amber 590nm |

\*Different colors are optional

## J Junction Options



01: Cable

## K Cable Direction Options

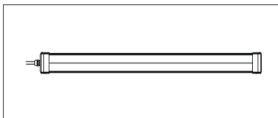

01: Single Entry

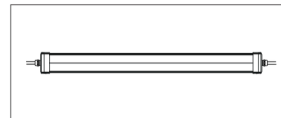

03: Dual end exit and entry

## U Upper Cover Options

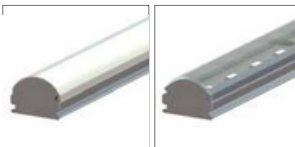

01: Diffused

02: Transparent

- Aluminum extrusion body
- UV-resistant PVC side covers
- Stainless steel mounting clips and hanging parts
- High-efficiency semi-transparent or opal PC diffuser



# LLKE - TECO

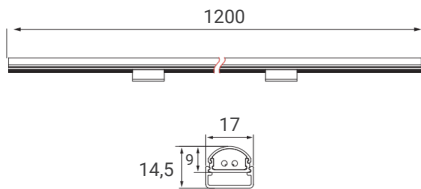

## P W Product & Power Options

| Product Name    | Light Color | Input Voltage (V) | Power (W) | Luminous Flux (lm) | Weight (kg) |
|-----------------|-------------|-------------------|-----------|--------------------|-------------|
| LLKE 120 - TECO | WW-NW-CW    | 24V DC            | 8,6       | 970                | 0,15        |

\*Power and Lumen values provided are based off of a coverless product with cold white (CW) LED.

## C Light Color Options

- WW: Warm White 3000K
- NW: Natural White 4000K
- CW: Cold White 6500K

## S System Options

- 01 Standart (ON/OFF)
- 02 PWM-DIM

- PVC end caps with UV protection
- Diffused polycarbonate top cover with UV protection
- Cooling capacity up to 7,2W/m
- Suitable for surface mounting
- Only produced as 120 cm

# CRAKE - TECO

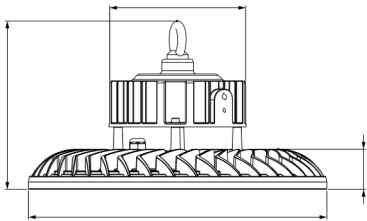
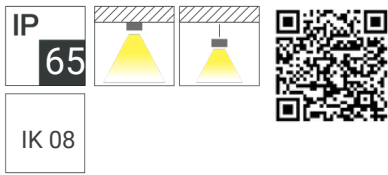

## P W Product & Power Options

| Product Name   | Light Color | Input Voltage (V) | Power (W) | Luminous Flux (lm) | Weight (kg) |
|----------------|-------------|-------------------|-----------|--------------------|-------------|
| CRAKE 1 - TECO | WW-NW-CW    | 220-240V AC       | 70        | 12.047             | 2,2         |
| CRAKE 1 - TECO | WW-NW-CW    | 220-240V AC       | 110       | 17.730             | 2,2         |

## C Light Color Options

- WW: Warm White 3000K
- NW: Natural White 4000K
- CW: Cold White 6500K

## S Driver Options

- 01** Standard Driver
- 06** Driver + Emergency Lighting Kit
- 16** Radar Sensor
- 23** 0-10V

## O Lens Options

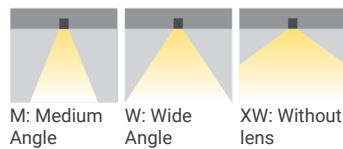

## M Mounting Options

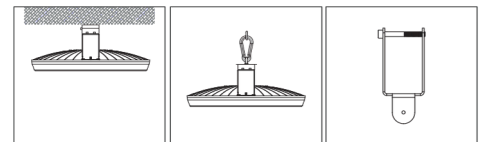

**M01:** Surface Cable Tray Mounting    **M02:** Pendant Mounting    **M03:** Busbar Hanger

- With overload, high temperature, high voltage protection industrial type led driver
- Efficiency up to 174 lm / W
- Electrostatic painted aluminum injection body
- Optional stainless steel mounting clip and hanger kit
- High temperature, high voltage protection
- Protection level IP 65

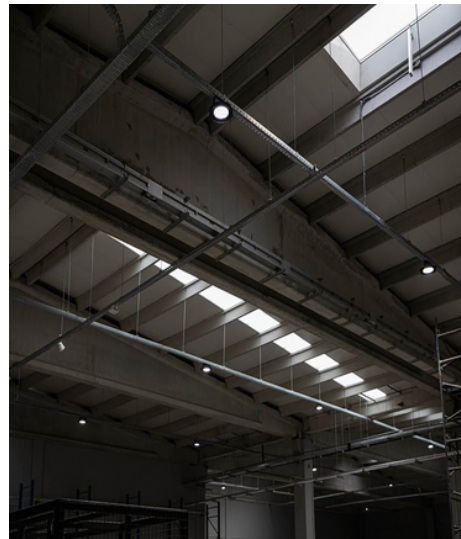

# CDEW - TECO

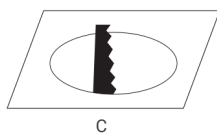
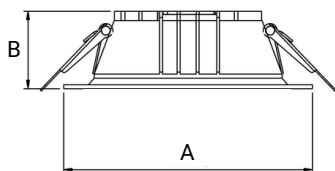

## P W Product & Power Options

| Product Name | Light Color | Input Voltage (V) | Power (W) | Luminous Flux (lm) | Dimensions (AxB) (mm) | Cutting Dimensions (C) (mm) | Weight (kg) |
|--------------|-------------|-------------------|-----------|--------------------|-----------------------|-----------------------------|-------------|
| CDEW4-TECO   | WW-NW-CW    | 220-240V AC       | 16        | 1.360              | Ø120x49               | Ø102                        | 0,4         |
| CDEW6-TECO   | WW-NW-CW    | 220-240V AC       | 20        | 1.750              | Ø177x55               | Ø152                        | 0,6         |
| CDEW8-TECO   | WW-NW-CW    | 220-240V AC       | 25        | 2.250              | Ø228x58               | Ø200                        | 0,9         |

\*Power and Lumen values provided are based off of a "cold white (CW) LED".

## C Light Color Options

|                    |       |
|--------------------|-------|
| ● WW:Warm White    | 3000K |
| ● NW:Natural White | 4000K |
| ● CWCold White     | 6500K |

\*Different colors are optional

## S Driver Options

- 01 Standard Driver
- 06 DALI Driver
- 11 Driver + Emergency Lighting Kit 1h
- 12 Driver + Emergency Lighting Kit 3h

## G Housing Color Options



RAL9005 RAL9007 RAL9016

- Electrostatic painted aluminum injection body and frame
- Low-glare (UGR <19) homogeneous light
- Stainless spring system for ceiling mounting
- Suitable for recessed mounting

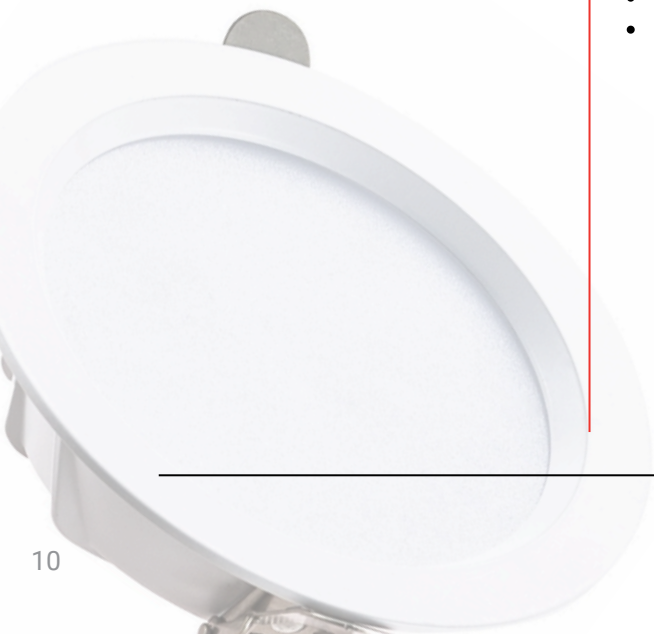

# CDRS - TECO

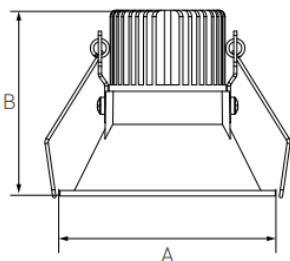

## P W Product & Power Options

| Product Name | Light Color | Input Voltage (V) | Power (W) | Luminous Flux (lm) | Dimensions (AxB) (mm) | Cutting Dimensions (C) (mm) | Weight (kg) |
|--------------|-------------|-------------------|-----------|--------------------|-----------------------|-----------------------------|-------------|
| CDRS85-TECO  | WW-NW-CW    | 220-240V AC       | 8         | 793                | Ø85x84                | Ø78                         | 0,2         |
| CDRS100-TECO | WW-NW-CW    | 220-240V AC       | 15        | 1206               | Ø100x87               | Ø90                         | 0,3         |

\*Power and Lumen values provided are based off of a "cold white (NW) LED".

## C Light Color Options

- WW: Warm White 3000K
- NW: Natural White 4000K
- CW: Cold White 6500K

\*Different colors are optional

## S Driver Options

- 01 Standard Driver
- 06 DALI Driver
- 11 Driver + Emergency Lighting Kit 1h
- 12 Driver + Emergency Lighting Kit 3h

- Electrostatic painted aluminum injection body and frame
- Low-glare (UGR <19) homogeneous light
- Stainless spring system for ceiling mounting
- Suitable for recessed mounting



# PANEL CLIP IN - TECO

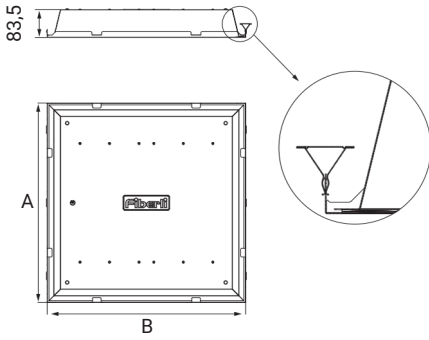

## P W Product & Power Options

| Product Name   | Light Color | Input Voltage (V) | Power (W) | Luminous Flux (lm) | Dimensions (AxB) (mm) | Weight (Kg) |
|----------------|-------------|-------------------|-----------|--------------------|-----------------------|-------------|
| PNLCLIPIN-3030 | WW-NW-CW    | 220-240V AC       | 18        | 2.160              | 300x300               | 1,1         |
| PNLCLIPIN-6060 | WW-NW-CW    | 220-240V AC       | 36        | 4.320              | 600x600               | 3,2         |
| PNLCLIPIN-6060 | WW-NW-CW    | 220-240V AC       | 54        | 6.400              | 600x600               | 3,2         |

\*Power and Lumen values provided are based off of a "cold white (CW) LED".

## C Light Color Options

|                     |       |
|---------------------|-------|
| ● WW: Warm White    | 3000K |
| ● NW: Natural White | 4000K |
| ● CW: Cold White    | 6500K |

Farklı renkler opsiyoneldir

## S Driver Options

- 01 Standard Driver
- 06 DALI Driver
- 11 Driver + Emergency Lighting Kit 1h
- 12 Driver + Emergency Lighting Kit 3h

- Electrostatic painted DKP body and frame
- High efficiency, low glare (UGR <19) homogeneous light
- Efficiency exceeding 100 lm/W with backlight technology
- Suitable for recessed installation

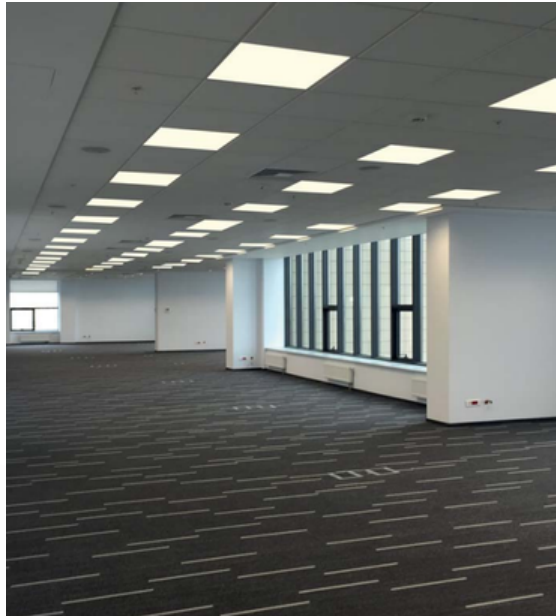

# PANEL LAY IN - TECO

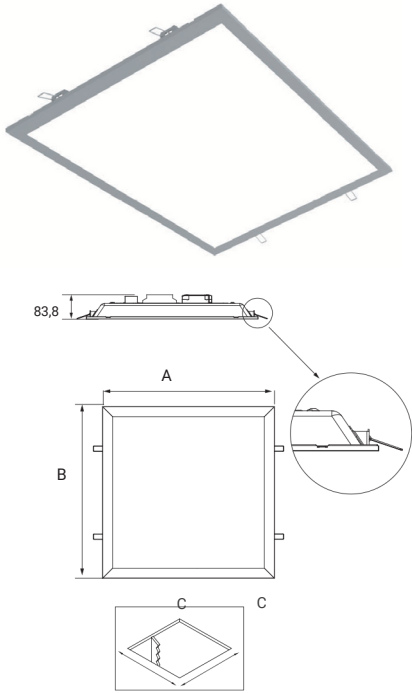

## P W Product & Power Options

| Product Name  | Light Color | Input Voltage (V) | Power (W) | Luminous Flux (lm) | Dimensions (Ax B) (mm) | Weight (Kg) |
|---------------|-------------|-------------------|-----------|--------------------|------------------------|-------------|
| PNLLAYIN-3030 | WW-NW-CW    | 220-240V AC       | 18        | 2.160              | 300x300                | 1,1         |
| PNLLAYIN-6060 | WW-NW-CW    | 220-240V AC       | 36        | 4.320              | 600x600                | 3,2         |
| PNLLAYIN-6060 | WW-NW-CW    | 220-240V AC       | 54        | 6.400              | 600x600                | 3,2         |

\*Power and Lumen values provided are based off of a "cold white (CW) LED".

## C Light Color Options

|   |                   |       |
|---|-------------------|-------|
|  | WW: Warm White    | 3000K |
|  | NW: Natural White | 4000K |
|  | CW: Cold White    | 6500K |

Farklı renkler opsiyoneldir

## S Driver Options

- 01 Standard Driver
- 06 DALI Driver
- 11 Driver + Emergency Lighting Kit 1h
- 12 Driver + Emergency Lighting Kit 3h

- Electrostatic painted DKP body and frame
- High efficiency, low glare (UGR <19) homogeneous light
- Efficiency exceeding 100 lm/W with backlight technology
- Suitable for drywall ceiling installation



# AC56 - TECO

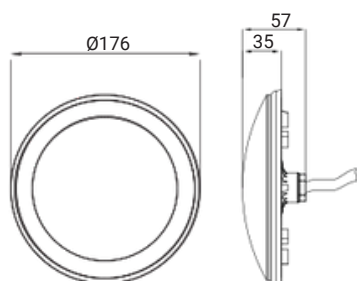
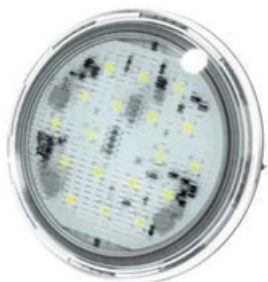

## P W Product & Power Options

| Product Name | Light Color | Input Voltage (V) | Power (W) | Luminous Flux (lm) | Weight (kg) |
|--------------|-------------|-------------------|-----------|--------------------|-------------|
| AC56-18      | WW-NW-CW    | 24V DC            | 18        | 1.800              | 0,8         |
| AC56-36      | WW-NW-CW    | 12-24V DC         | 18        | 1.800              | 0,8         |

Power and Lumen values provided are based off of a "cold white (CW) LED". It may vary according to the desired color.

## C Light Color Options

|                           |               |
|---------------------------|---------------|
| ● WW: Warm White 3000K    | ● Red 625nm   |
| ● NW: Natural White 4000K | ● Green 525nm |
| ● CW: Cold White 6500K    | ● Blue 465 nm |

## S System Options

- 01 Standart (ON/OFF)
- 02 PWM-DIM

- Plastic injection PC body
- Polycarbonate glass
- Operates with alternate or direct current
- Underwater connector
- H07RNF rubber cable
- Only PAR 56 lamp with LED is included.
- Mounting shell and pieces are not included

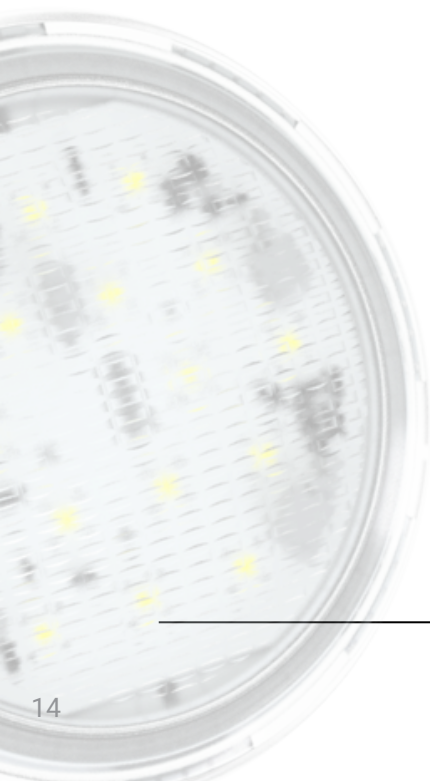

# TecoLED Price List

| PRODUCT NAME         | FEATURE | MINIMUM ORDER QUANTITY (pcs) | UNIT PRICE (USD/PCD) |
|----------------------|---------|------------------------------|----------------------|
| WH4 - TECO           | 30 W    | 100                          |                      |
| WH4 - TECO           | 50 W    | 100                          |                      |
| WH6 - TECO           | 75 W    | 50                           |                      |
| WH6 - TECO           | 100 W   | 50                           |                      |
| WH9 - TECO           | 150 W   | 50                           |                      |
| WH16 - TECO          | 200 W   | 50                           |                      |
| WH16 - TECO          | 250 W   | 50                           |                      |
| RODA60 - EVO         | 18 W    | 250                          |                      |
| RODA120 - EVO        | 36 W    | 250                          |                      |
| LLTMS60 - TECO       | 18 W    | 250                          |                      |
| LLTMS120 - TECO      | 36 W    | 250                          |                      |
| LLKE 120 - TECO      | 8,6 W   | 40                           |                      |
| CRAKE 1 - TECO       | 70 W    | 100                          |                      |
| CRAKE 1 - TECO       | 110 W   | 100                          |                      |
| CDEW4 - TECO         | 16 W    | 250                          |                      |
| CDEW6 - TECO         | 20 W    | 250                          |                      |
| CDEW8 - TECO         | 25 W    | 250                          |                      |
| CDRS85 - TECO        | 8 W     | 100                          |                      |
| CDRS100 - TECO       | 15 W    | 100                          |                      |
| PANEL CLIP IN - TECO | 18 W    | 100                          |                      |
| PANEL CLIP IN - TECO | 36 W    | 100                          |                      |
| PANEL CLIP IN - TECO | 54 W    | 100                          |                      |
| PANEL LAY IN - TECO  | 18 W    | 100                          |                      |
| PANEL LAY IN - TECO  | 36 W    | 100                          |                      |
| PANEL LAY IN - TECO  | 54 W    | 100                          |                      |
| AC56 - TECO          | 18 W    | 250                          |                      |
| AC56 - TECO          | 18 W    | 250                          |                      |

- This price list is valid as of 01.01.2025. Our prices are subject to change without prior notice depending on market conditions.
- The stated prices do not include VAT. VAT and other applicable taxes will be added at the invoicing stage.
- Prices are calculated excluding delivery costs to the delivery location. Shipping costs are the buyer's responsibility.
- For orders that do not comply with the specified minimum order quantity, price adjustments may apply.
- The warranty period for Teco series products is 2 years. Please contact us for additional warranty terms.





TecoLED



*Minimal design, Maximum power*

---

PSL Elektronik San. ve Tic. A.Ş  
[www.fiberli.com](http://www.fiberli.com)