



RDM/DMX & Animasyon

LL

DP

CD

WW

CS

CF

AC

CG

CB

HB

MM

RDMX

LC

FO

EL

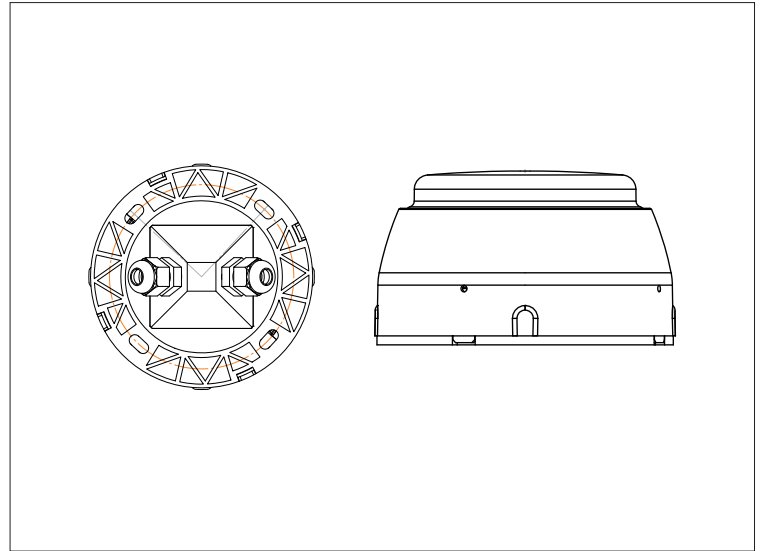

RDMX

Cephe aydınlatma alanının öncü üreticilerinden biri Fiberli, RDM protokollü yeni kategorisi ile geniş ürün gamı sunuyor. Otel, iş merkezi, AVM gibi çizgisel veya cephe aydınlatma çözümlerinin yanı sıra zemine gömme armatürler ile de animasyon aydınlatma kategorisini zenginleştiriyor. Cihazdan merkeze geri data aktarımı sunan RDM protokolü sayesinde sahadaki ürünlerin çalışma istatistikleri ve arıza verileri kayıt edilebiliyor. Ayrıca hızlı renk geçişi sayesinde cephelerde etkileyici RGB renk uygulamaları ile aydınlatma tasarımına yeni bir boyut getiriyor.

RDM/DMX & Animasyon

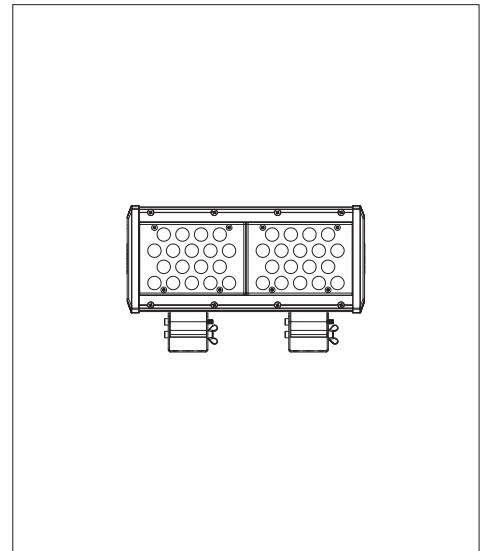
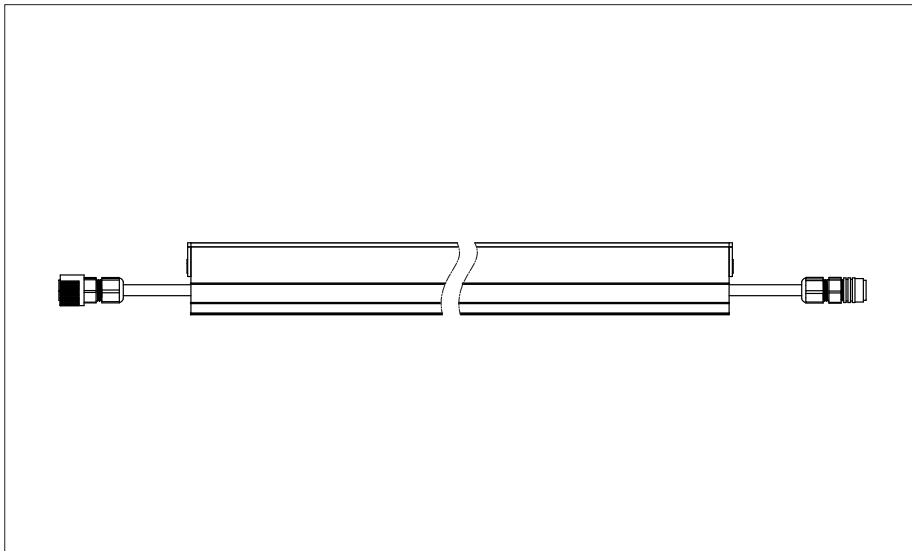

RDMX - RDM/DMX & Animasyon



IP
66



RDMX

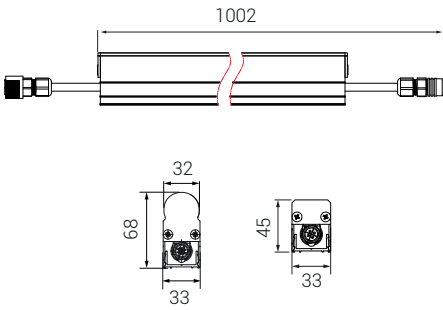

- Elokсалlı alüminyum ekstrüzyon profil
- Paslanmaz bağlantı parçaları
- UV korumalı PVC yan kapak
- UV korumalı, difüze ön kapak
- 36W / m'ye kadar soğutma kapasitesi
- Maksimum 4 metrelik parçalar haline üretilebilir
- RDMX yapılandırması
- Veri Sinyalleri için IP67 soket

P W Ürün ve Güç Seçenekleri

Model	Işık Rengi	Voltaj (V)	Güç (W)	Ölçüler (mm)	LED Miktarı (ad)	Piksel Aralığı (cm)
LL-RDMX-10-4X2,5	RGB	15-48V DC	2	102	4	4x2,5
LL-RDMX-50-4X2,5	RGB	15-48V DC	6	502	20	4x2,5
LL-RDMX-100-4X2,5	RGB	15-48V DC	11	1002	40	4x2,5
LL-RDMX-150-4X2,5	RGB	15-48V DC	16	1502	60	4x2,5

U Üst Parça Seçenekleri



01: Difüze kapak



02: Düz Difüze kapak



03: Düz Polimer kapak

M Montaj Seçenekleri

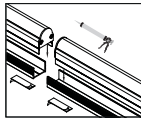

02: Silikon + Çift taraflı bant montajı

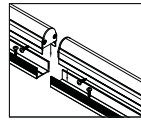

14: Vidalı montaj



Sipariş Kodu

P . W . U . M



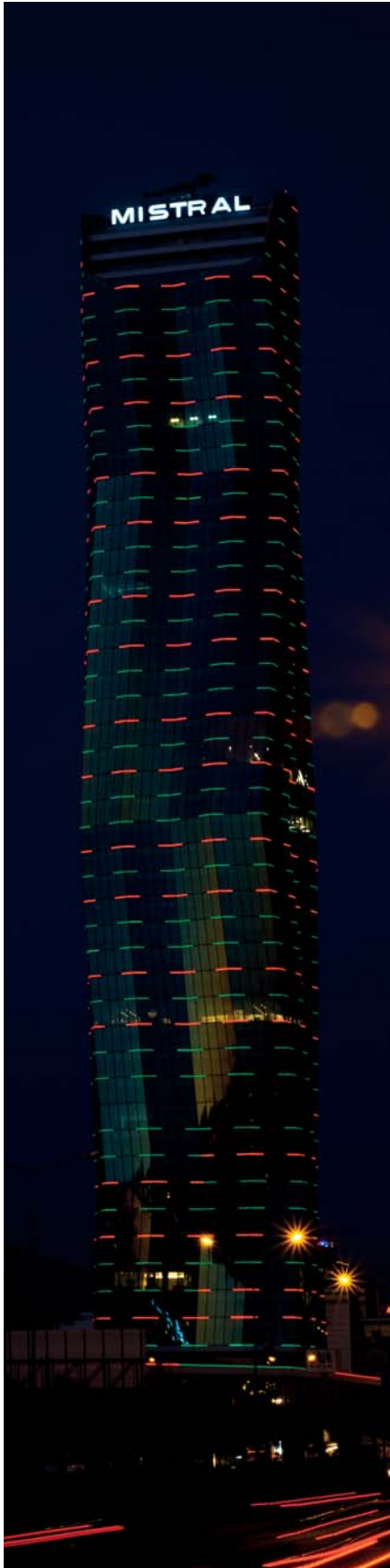

Mistral Tower, İzmir

Standart Bağlantı Şeması



Uzatma Soketli Bağlantı Şeması

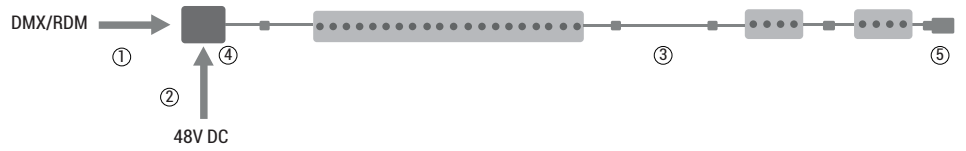

Kombine Modelli Bağlantı Şeması

DOT-RDMX-xx ve LL-RDMX-xxx, DOT-RDMX ve LL-RDMX birleştirilerek, karışık model DOT/LL zinciri oluşturulabilir.

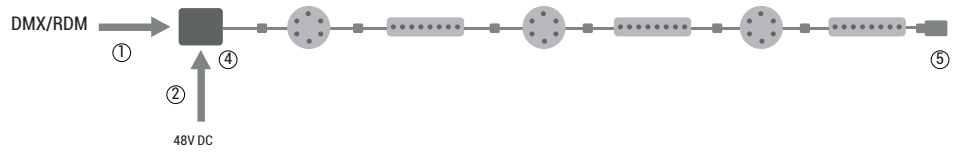

(1) DMX DATA Kablo, 33400474: Kablo 2X0,22 KR-SY LI2Y(ST)CH TP Gri

(2) AC Besleme Kablosu, 3x1mm TTR

(3) 26000xxx : Soket RDMX L:100/200/400/600/800/1000cm 4 PIN dişi-erkek çift taraflı uzatma IP67 (YM)



(4) 33600695:
RDMX Giriş bağlantı kutusu



(5) 33600696:
RDMX Terminator

Aksesuarlar

33400474: Kablo 2X0,22 KR-SY LI2Y(ST)CH TP Gri

26000122: Soket RDMX L:100cm 4 PIN dişi-erkek çift taraflı uzatma IP67 (YM)

26000150: Soket RDMX L:200cm 4 dişi-erkek çift taraflı uzatma IP67 (YM)

26000151: Soket RDMX L:400cm 4 dişi-erkek çift taraflı uzatma IP67 (YM)

26000152: Soket RDMX L:600cm 4 dişi-erkek çift taraflı uzatma IP67 (YM)

26000153: Soket RDMX L:800cm 4 dişi-erkek çift taraflı uzatma IP67 (YM)

26000154: Soket RDMX L:1000cm 4 dişi-erkek çift taraflı uzatma



RDMX

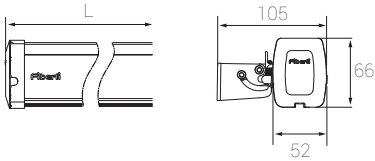

- Elokсалlı alüminyum ekstrüzyon profil
- Polikarbon armatür camı
- UV korumalı gizli rakor çıkışlı PVC yan kapaklar
- Paslanmaz krom armatür ayağı
- Yüksek verimli grup lens
- IP68 havalandırma
- RDMX yapılandırması
- Veri Sinyalleri için IP67 soket

P W Ürün ve Güç Seçenekleri

Ürün Adı	Işık Rengi	Voltaj (V)	Güç (W)	Uzunluk (L) (mm)	Ağırlık (kg)
WL109-RDMX	RGB	220-240V AC	12	380	1,0
WL218-RDMX	RGB	220-240V AC	23	619	1,5
WL327-RDMX	RGB	220-240V AC	34	909	2,4
WL436-RDMX	RGB	220-240V AC	45	1199	2,9
WL112-RDMX	RGBW/A	220-240V AC	16	380	1,0
WL224-RDMX	RGBW/A	220-240V AC	31	619	1,5
WL336-RDMX	RGBW/A	220-240V AC	45	909	2,4
WL448-RDMX	RGBW/A	220-240V AC	60	1199	2,9

O Lens Seçenekleri



XN: Ekstra Dar Açılı N: Dar Açılı M: Orta Açılı W: Geniş Açılı E: Eliptik Açılı

J Bağlantı Seçenekleri



01: Kablolü 02: IP Soketli
*Yalnızca 220V AC yapılabilir.

K Kablo Giriş Yönü Seçenekleri

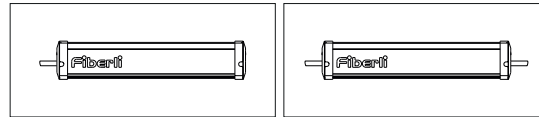

01: Tek yönden giriş 03: Çift yönden giriş-çıkış*
*Sadece enerji kablosu için



Sipariş Kodu

P . W . O . J . K . M



Ürün Diyagramları

Polare Diyagramı

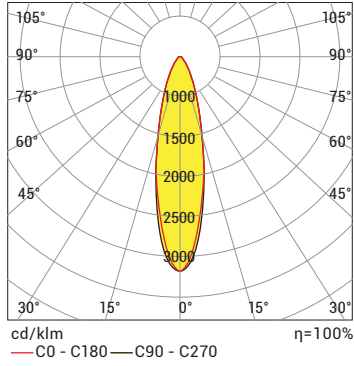

Koni Diyagramı

H (mt)	\emptyset (m)	E _{max} (lx)
0.5	0,22	12935
1.0	0,44	3234
1.5	0,66	1437
2.0	0,88	808
2.5	1,10	517
3.0	1,32	359

WL109 CW 10D 12 W 220V AC IP66

Polare Diyagramı

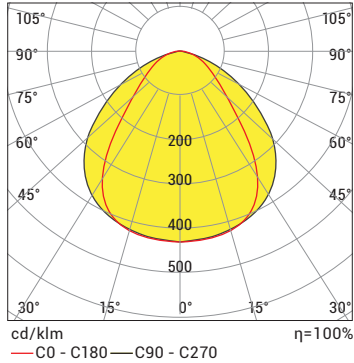

Koni Diyagramı

H (mt)	\emptyset (m)	E _{max} (lx)
0.5	0,84	1674
1.0	1,68	419
1.5	2,53	186
2.0	3,37	105
2.5	4,21	67
3.0	5,05	47

WL109 CW 120D 12 W 220V AC IP66

M Montaj Seçenekleri

Ayak Bağlantısı

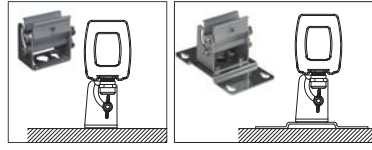

20: Standart ayak

21: Standart ayak ve montaj aparatı

Opsiyonel Aksesuarlar

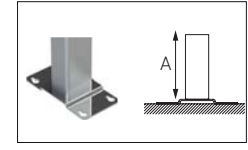

34: Uzatma parçası A=5cm
35: Uzatma parçası A=10cm
36: Uzatma parçası A=20cm
Harici olarak istenilen uzunlukta uzatma parçası üretilebilir.

Birleştirme Bağlantı Parçaları



Ek Parça Seçenekleri



İkili Birleştirme



Üçlü Birleştirme



Dörtlü Birleştirme



Standart Bağlantı Şeması

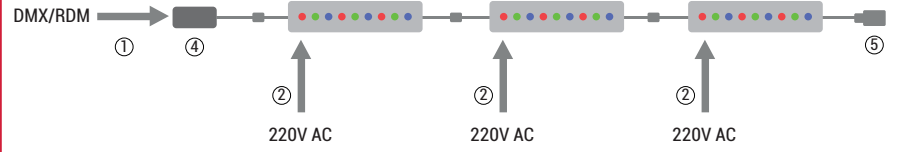

Uzatma Soketli Bağlantı Şeması

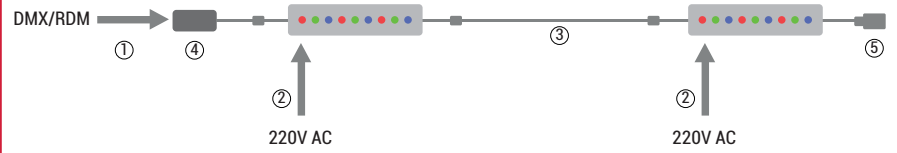

(1) DMX DATA Kablo, 33400474: Kablo 2X0,22 KR-SY LI2Y(ST)CH TP Gri

(2) AC SUPPLY Kablo, 3x1mm TTR

(3) 26000xxx: Soket RDMX L:100/200/400/600/800/1000cm 4 dişi-erkek çift taraflı uzatma IP67 (YM)



(4) 33600755:
RDMX INPUT JOINT



(5) 33600696:
RDMX TERMINATOR

Aksesuarlar

33400474: CABLE 2X0,22 KR-SY LI2Y(ST)CH TP GREY

26000122: SOCKET RDMX L: 100cm 4 PIN dişi-erkek çift taraflı uzatma IP67 (YM)

26000150: SOCKET RDMX L: 200cm 4 PIN dişi-erkek çift taraflı uzatma IP67 (YM)

26000151: SOCKET RDMX L: 400cm 4 PIN dişi-erkek çift taraflı uzatma IP67 (YM)

26000152: SOCKET RDMX L: 600cm 4 PIN dişi-erkek çift taraflı uzatma IP67 (YM)

26000153: SOCKET RDMX L: 800cm 4 PIN dişi-erkek çift taraflı uzatma IP67 (YM)

26000154: SOCKET RDMX L: 1000cm 4 PIN dişi-erkek çift taraflı uzatma





RDMX

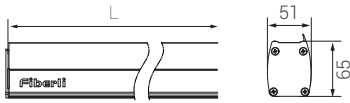
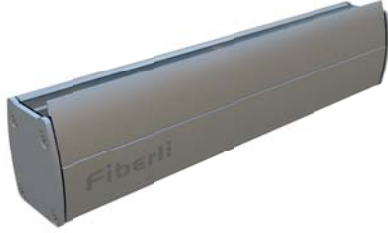

- Elokсалlı alüminyum ekstrüzyon profil
- Polikarbon armatür camı
- UV korumalı gizli rakor çıkışlı PVC yan kapaklar
- Paslanmaz krom armatür ayağı
- Yüksek verimli grup lens
- IP68 havalandırma
- RDMX yapılandırması
- Veri Sinyalleri için IP67 soket

P W Ürün ve Güç Seçenekleri

Ürün Adı	Işık Rengi	Voltaj (V)	Güç (W)	Uzunluk (L) (mm)	Ağırlık (kg)
WLT109-RDMX	RGB	220-240V AC	12	360	1,0
WLT218-RDMX	RGB	220-240V AC	23	600	1,5
WLT327-RDMX	RGB	220-240V AC	34	900	2,4
WLT436-RDMX	RGB	220-240V AC	45	1190	2,9
WLT112-RDMX	RGBW/A	220-240V AC	16	360	1,0
WLT224-RDMX	RGBW/A	220-240V AC	31	600	1,5
WLT336-RDMX	RGBW/A	220-240V AC	45	900	2,4
WLT448-RDMX	RGBW/A	220-240V AC	60	1190	2,9

O Lens Seçenekleri



XN: Ekstra Dar Açılı N: Dar Açılı M: Orta Açılı W: Geniş Açılı E: Eliptik Açılı

J Bağlantı Seçenekleri



01: Kablolu 02: IP Soketli
*Yalnızca 220v AC yapılabilir.

U Üst Parça Seçenekleri

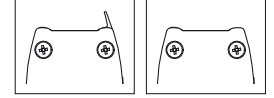

Siperli Sipersiz

K Kablo Giriş Yönü Seçenekleri



01: Tek yönden giriş 03: Çift yönden giriş-çıkış*
*Sadece enerji kablosu için

M Montaj Seçenekleri

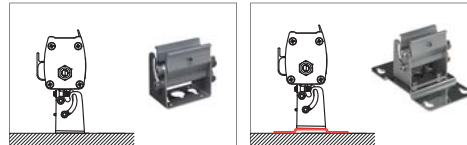

20: Standart ayak 21: Standart ayak ve montaj aparatı

Opsiyonel Aksesuarlar

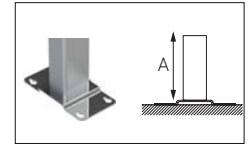

34: Uzatma parçası A=5cm
35: Uzatma parçası A=10cm
36: Uzatma parçası A=20cm

Harici olarak istenilen uzunlukta uzatma parçası üretilebilir.



Sipariş Kodu

P . W . O . J . U . K . M



Ürün Diyagramları

Polar Diyagramı

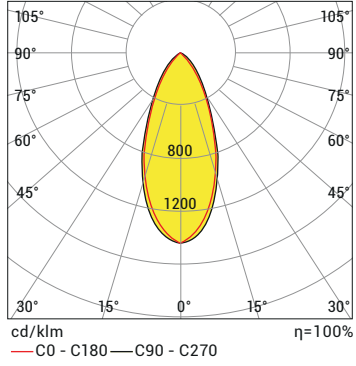

Kütüphane, Türkmenistan

Standart Bağlantı Şeması

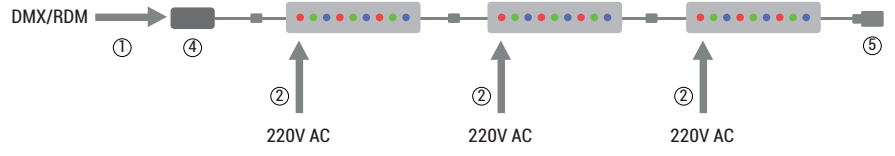

Uzatma Soketli Bağlantı Şeması

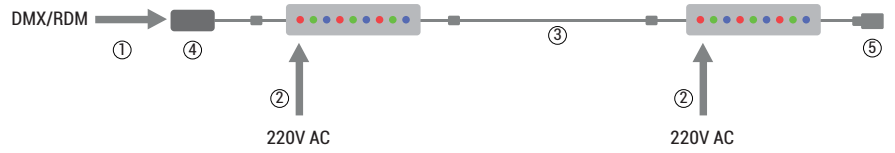

(1) DMX DATA Kablo, 33400474 : Kablo 2X0,22 KR-SY LI2Y(ST)CH TP Gri

(2) AC SUPPLY Kablo, 3x1mm TTR

(3) 26000xxx : Soket RDMX L:100/200/400/600/800/1000cm 4 dişi-erkek çift taraflı uzatma IP67 (YM)



(4) 33600755:
RDMX INPUT JOINT



(5) 33600696:
RDMX TERMINATOR

Accessories

33400474: Kablo 2X0,22 KR-SY LI2Y(ST)CH TP Gri

26000122: Soket RDMX L: 100cm 4 PIN dişi-erkek çift taraflı uzatma IP67 (YM)

26000150: Soket RDMX L: 200cm 4 PIN dişi-erkek çift taraflı uzatma IP67 (YM)

26000151: Soket RDMX L: 400cm 4 PIN dişi-erkek çift taraflı uzatma IP67 (YM)

26000152: Soket RDMX L: 600cm 4 PIN dişi-erkek çift taraflı uzatma IP67 (YM)

26000153: Soket RDMX L: 800cm 4 PIN dişi-erkek çift taraflı uzatma IP67 (YM)

26000154: Soket RDMX L: 1000cm 4 PIN dişi-erkek çift taraflı uzatma



RDMX

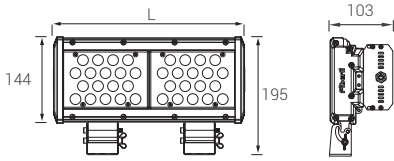

- Elokssallı alüminyum ekstrüzyon profil
- Elektrostatik toz boya kaplı alüminyum enjeksiyon kapak
- Polikarbon armatür camı
- UV korumalı gizli rakor çıkışı PVC yan kapaklar
- Paslanmaz krom armatür ayağı
- Yüksek verimli grup lens
- IP68 havalandırma
- RDMX yapılandırması
- Veri Sinyalleri için IP67 soket

P W Ürün ve Güç Seçenekleri

Ürün Adı	Işık Rengi	Voltaj (V)	Güç (W)	Uzunluk (L) (mm)	Ağırlık (kg)
WS236-RDMX	RGB	220-240V AC	45	320	2,9
WS354-RDMX	RGB	220-240V AC	67	477	4,3
WS472-RDMX	RGB	220-240V AC	89	609	5,3
WS232-RDMX	RGBW/A	220-240V AC	59	320	2,9
WS348-RDMX	RGBW/A	220-240V AC	88	477	4,3
WS464-RDMX	RGBW/A	220-240V AC	117	609	5,3

O Lens Seçenekleri



N: Dar Açılı M: Orta Açılı W: Geniş Açılı

J Bağlantı Seçenekleri



01: Kablolu 02: IP67 Soketli

M Montaj Seçenekleri



20: Standart ayak 21: Standart ayak ve montaj aparatı

Opsiyonel Aksesuarlar

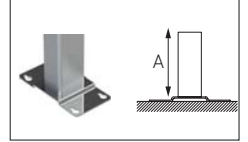

34: Uzatma parçası A=5cm
35: Uzatma parçası A=10cm
36: Uzatma parçası A=20cm
Harici olarak istenilen uzunlukta uzatma parçası üretilebilir.

Birleştirme Bağlantı Parçaları

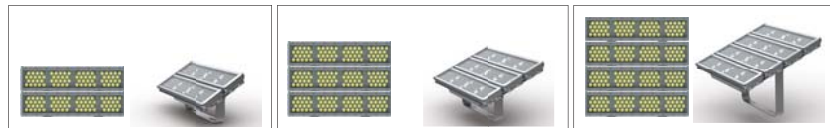

İkili Birleştirme

Üçlü Birleştirme

Dörtlü Birleştirme



Sipariş Kodu

P . W . O . J . M



Ürün Diyagramları

Polar Diyagramı

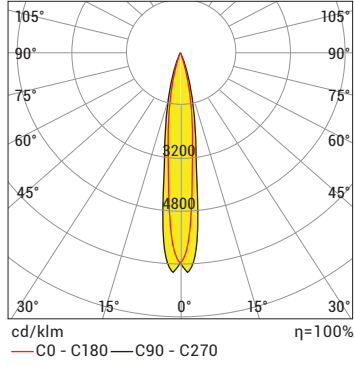

Koni Diyagramı

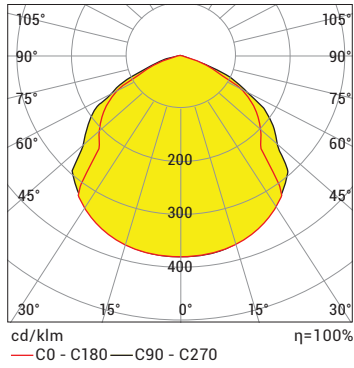

Standart Bağlantı Şeması

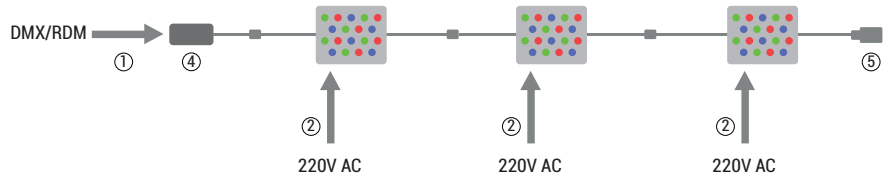

Uzatma Soketli Bağlantı Şeması

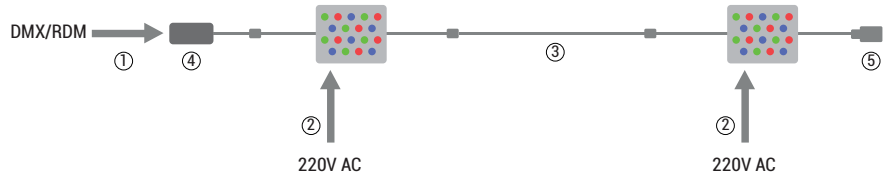

(1) DMX DATA Kablo, 33400474 : Kablo 2X0,22 KR-SY LI2Y(ST)CH TP Gri

(2) AC Besleme Kablosu, 3x1 mm TTR

(3) 26000xxx : Soket RDMX L:100/200/400/600/800/1000cm 4 PIN dişi-erkek çift taraflı uzatma IP67 (YM)



(4) 33600755:
RDMX INPUT JOINT



(5) 33600696:
RDMX TERMINATOR

Aksesuarlar

33400474: Kablo 2X0,22 KR-SY LI2Y(ST)CH TP Gri

26000122: Soket RDMX L: 100cm 4 PIN dişi-erkek çift taraflı uzatma IP67 (YM)

26000150: Soket RDMX L: 200cm 4 PIN dişi-erkek çift taraflı uzatma IP67 (YM)

26000151: Soket RDMX L: 400cm 4 PIN dişi-erkek çift taraflı uzatma IP67 (YM)

26000152: Soket RDMX L: 600cm 4 dişi-erkek çift taraflı uzatma IP67 (YM)

26000153: Soket RDMX L: 800cm 4 dişi-erkek çift taraflı uzatma IP67 (YM)

26000154: Soket RDMX L: 1000cm 4 dişi-erkek çift taraflı uzatma



RDMX

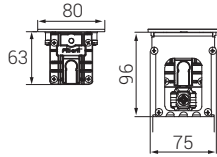
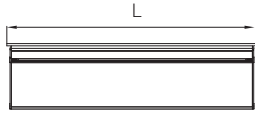

- Eloksallı alüminyum ekstrüzyon gövde
- Eloksallı alüminyum ekstrüzyon montaj Kutusu
- 316 L saten krom dış çerçeve
- 6mm temperli armatür camı
- UV korumalı PVC kapaklar
- Sualtı kablo bağlantısı
- H07RNF Kauçuk Kablo
- IP68 havalandırma
- RDMX yapılandırması
- Veri Sinyalleri için IP67 soket

P W Ürün ve Güç Seçenekleri

Ürün Adı	Işık Rengi	Voltaj (V)	Güç (W)	Uzunluk (L) (mm)	Ağırlık (kg)
CFL109-RDMX	RGB	220-240V AC	12	380	2,5
CFL218-RDMX	RGB	220-240V AC	23	670	4,0
CFL327-RDMX	RGB	220-240V AC	34	960	5,1
CFL436-RDMX	RGB	220-240V AC	45	1250	7,3
CFL112-RDMX	RGBW/A	220-240V AC	16	380	2,5
CFL224-RDMX	RGBW/A	220-240V AC	31	670	4,0
CFL336-RDMX	RGBW/A	220-240V AC	45	960	5,1
CFL448-RDMX	RGBW/A	220-240V AC	60	1250	2,9

O Lens Seçenekleri



XN: Ekstra Dar Açılı N: Dar Açılı M: Orta Açılı W: Geniş Açılı E: Eliptik Açılı



NA: Asimetrik Dar Açılı MA: Asimetrik Orta Açılı

K Kablo Giriş Yönü Seçenekleri

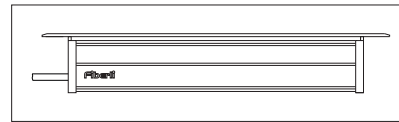

01: Tek yönden giriş

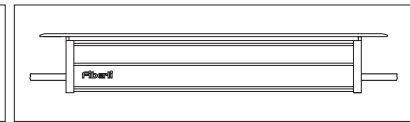

03: Çift yönden giriş-çıkış*

*Sadece enerji kablosu için



Sipariş Kodu

P . W . O . K . M



Ürün Diyagramları

Polar Diyagramı

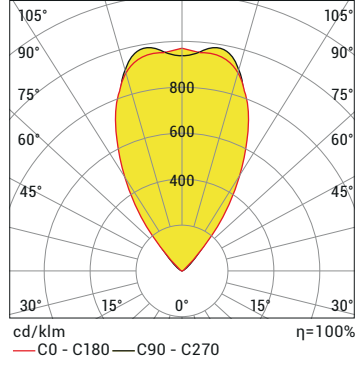

Standart Bağlantı Şeması

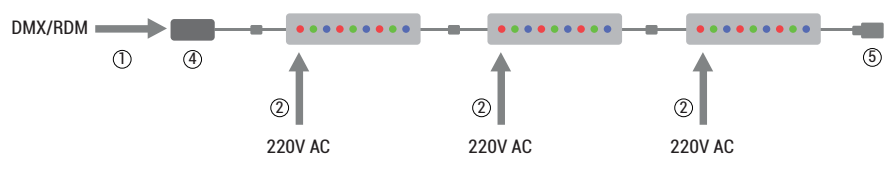

Uzatma Soketli Bağlantı Şeması

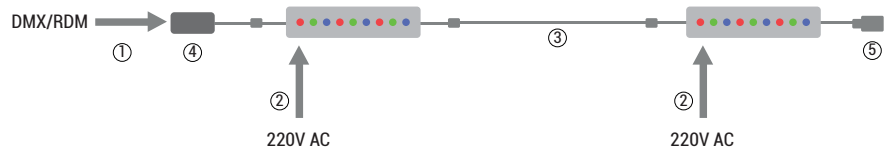

(1) DMX DATA Kablo, 33400474 : Kablo E 2X0,22 KR-SY LI2Y(ST)CH TP Gri

(2) AC Besleme Kablosu, 3x1mm TTR

(3) 26000xxx : Soket RDMX L:100/200/400/600/800/1000cm 4 dişi-erkek çift taraflı uzatma IP67 (YM)



(4) 33600755:
RDMX INPUT JOINT



(5) 33600696:
RDMX TERMINATOR

Aksesuarlar

33400474: Kablo 2X0,22 KR-SY LI2Y(ST)CH TP Gri

26000122: Soket RDMX L: 100cm 4 PIN dişi-erkek çift taraflı uzatma IP67 (YM)

26000150: Soket RDMX L: 200cm 4 PIN dişi-erkek çift taraflı uzatma IP67 (YM)

26000151: Soket RDMX L: 400cm 4 PIN dişi-erkek çift taraflı uzatma IP67 (YM)

26000152: Soket RDMX L: 600cm 4 PIN dişi-erkek çift taraflı uzatma IP67 (YM)

26000153: Soket RDMX L: 800cm 4 PIN dişi-erkek çift taraflı uzatma IP67 (YM)

26000154: Soket RDMX L: 1000cm 4 PIN dişi-erkek çift taraflı uzatma

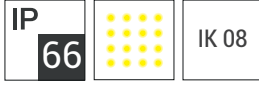

RDMX

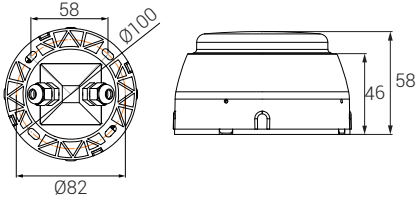

- Plastik enjeksiyon gövde
- Polikarbon armatür camı
- RDM yapılandırması
- Veri Sinyalleri için IP67 soket

P W Ürün ve Güç Seçenekleri

Ürün Adı	Işık Rengi	Voltaj (V)	Güç (W)	Ağırlık (kg)
DOT-RDMX-6	RGB	12-48V DC	2	0,2
DOT-RDMX-12	RGB	12-48V DC	3	0,2
DOT-RDMX-18	RGB	12-48V DC	5	0,2

G Gövde Rengi Seçenekleri



RAL9005 RAL9016 RAL9007

U Üst Parça Seçenekleri



9: Diffüze

11: Şeffaf



Sipariş Kodu

P . W . G . U





Alparslan Türkeş Köprüsü, Manisa

Standart Bağlantı Şeması

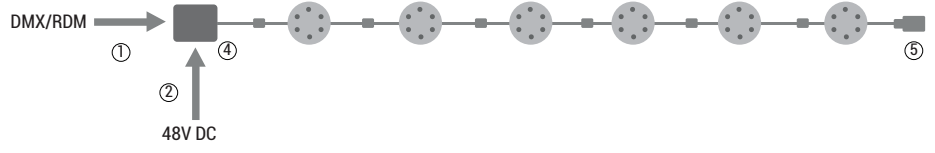

Uzatma Soketli Bağlantı Şeması

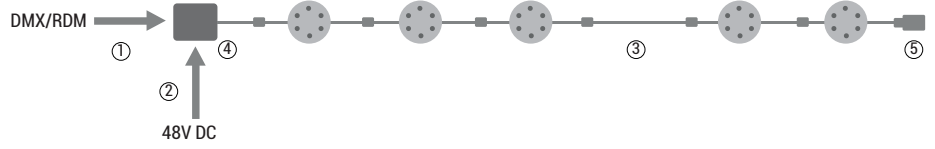

Kombine Modelli Bağlantı Şeması

DOT-RDMX-xx ve LL-RDMX-xxx, DOT-RDMX ve LL-RDMX birleştirilerek, karışık model DOT/LL zinciri oluşturulabilir

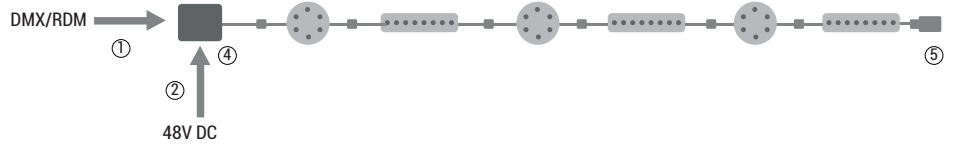

(1) DMX DATA Kablo, 33400474 : CABLE 2X0,22 KR-SY LI2Y(ST)CH TP Gri

(2) AC Besleme Kablosu, 3x1mm TTR

(3) 26000xxx : SOCKET RDMX L:100/200/400/600/800/1000cm 4 PIN dişi-erkek çift taraflı uzatma IP67 (YM)



(4) 33600695:
RDMX Giriş bağlantı kutusu



(5) 33600696:
RDMX Terminator

Aksesuarlar

33400474: Kablo 2X0,22 KR-SY LI2Y(ST)CH TP Gri

26000122: Soket RDMX L:100cm 4 PIN dişi-erkek çift taraflı uzatma IP67 (YM)

26000150: Soket RDMX L:200cm 4 PIN dişi-erkek çift taraflı uzatma IP67 (YM)

26000151: Soket RDMX L:400cm 4 PIN dişi-erkek çift taraflı uzatma IP67 (YM)

26000152: Soket RDMX L:600cm 4 PIN dişi-erkek çift taraflı uzatma IP67 (YM)

26000153: Soket RDMX L:800cm 4 PIN dişi-erkek çift taraflı uzatma IP67 (YM)

26000154: Soket RDMX L:1000cm 4 PIN dişi-erkek çift taraflı uzatma